

## ■ ABM-28 | PORTABLE AUTO FEED MACHINE

This latest generation portable beveling machine performs auto feed beveling on steel plates on top, face and bottom edges.



### ■ Most important features include:

- Auto-feed portable beveling.
- Continuously adjustable bevel angle between 60 and minus 60 degrees, eliminating the need to turn a plate over
- Max. bevel width (depending on the beveled angle) from 28 up to 35 mm
- Variable feed control for work on a variety of steel grades and thicknesses (up to 35 mm as standard or optionally up to 70 mm)
- Beveling in both travel directions
- Motor overload protection
- J groove beveling available as option
- Quick setup
- Extendable rails



The ABM-28 can perform beveling along steel plate's edge in both travel directions eliminating hard physical work of the operator.

Required length of the guide track (rail) can be accomplished with additional sections of guide tracks.

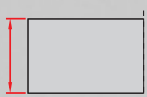
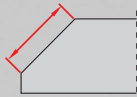

Plate thickness  
max 35 mm  
36-70 mm (option)



Bevel width  
up to 35 mm



Bevel angle  
from 60 to  
minus 60°



Top beveling

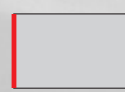

Facing off



Bottom  
beveling



Clad removal (option)  
depth up to 5 mm (1/5")  
width up to 25 mm (1")

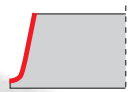

J-groove  
beveling  
(option)

ABM-28 TECHNICAL SPECIFICATION	
Voltage	~220-240 V, 50-60 Hz
Power	1600 W
Spindle speed (no load)	2780 rpm
Bevel angle ( $\beta$ )	60 to $-60^\circ$
Maximum bevel width (b)	35 mm (1.38")
Feed speed	250 - 500 mm/min
Plate thickness	max 35 mm, 36-70 mm (option)
Weight (machine with 1 guide track)	53.5 kg (118 lbs)
Product Code	UKS-0518-10-20-00-0

$\beta$	0°	30°	45°	60°
b	35 mm	30 mm	28 mm	30 mm

Maximum bevel width depends on the beveled angle

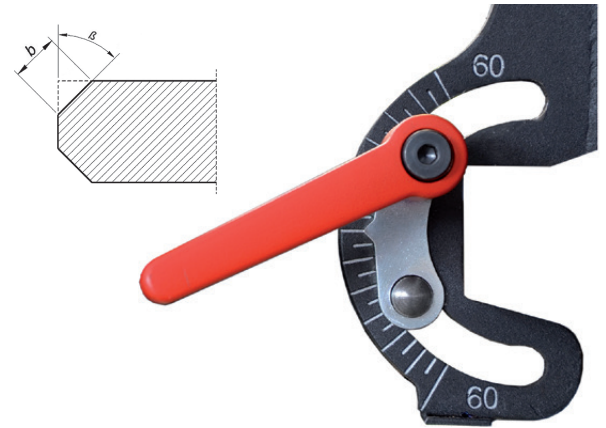

Milling heads for beveling (standard) and for J-groove (option)



### Standard shipping set:

1. Carriage mounted on a guide track
2. Milling unit
3. Milling unit support for beveling at  $60^\circ$  to  $-60^\circ$
4. Additional guide track section
5. Track clamp for 10-35 mm thick plates (3 pcs)
6. Chip container
7. Set of tools
8. Clamp for 10-35 mm thick plates (2 pcs)
  - Wooden box
  - Operator's Manual

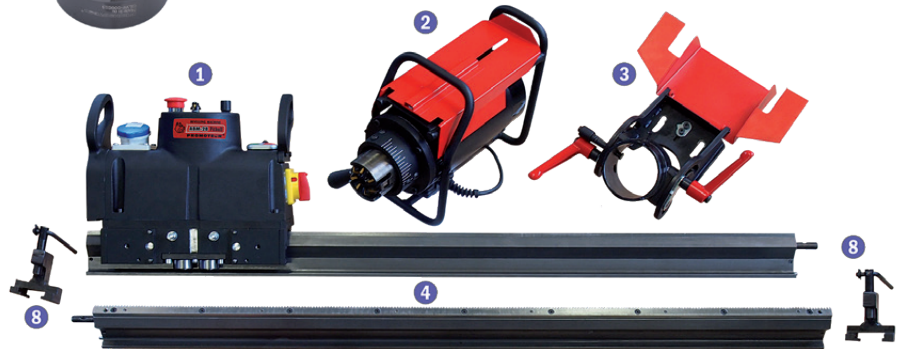

### Accessories and optional equipment:

- GLW-000013 Milling head (7 inserts required)
- PLY-000282 Cutting insert (1 piece), sold 10pcs/box
- PLY-000591 Cutting insert HD (1 piece), sold 10pcs/box
- GLW-0518-07-03-00-0 J-groove R6 milling head (6 inserts R6 required)
- PLY-000422 Cutting insert for J-groove R6 end preparation
- GLW-0518-07-04-00-0 J-groove R8 milling head (5 inserts R8 required)
- PLY-000424 Cutting insert for J-groove R8 end preparation
- ZSP-0518-13-00-00-0 Guide track L=1200mm (47.25")
- UST-0152-99-02-00-0 Track clamp for 10-35mm thick plates
- UST-0152-15-01-00-1 Track clamp for 36-70 mm thick plates
- ZCS-0152-99-00-00-0 Clamp for 10-35 mm thick plates
- ZCS-0152-99-01-00-0 Clamp for 36-70 mm thick plates
- WSP-0518-03-00-00-0 Milling unit support for beveling 10-35mm thick plates from  $-60^\circ$  to  $60^\circ$
- WSP-0518-04-00-00-0 Milling unit support for beveling 36-70 mm thick plates at  $0^\circ$  to  $60^\circ$  (incl. facing)
- WSP-0518-05-00-00-0 Milling unit support for beveling 36-70 mm thick plates at  $0^\circ$  to  $-60^\circ$
- ZST-0518-07-00-00-0 12° Angle attachment with height adjustment
- ZST-0518-09-00-00-0 Clad removal attachment incl. milling unit support and 3 track clamps for up to 35 mm thick plate

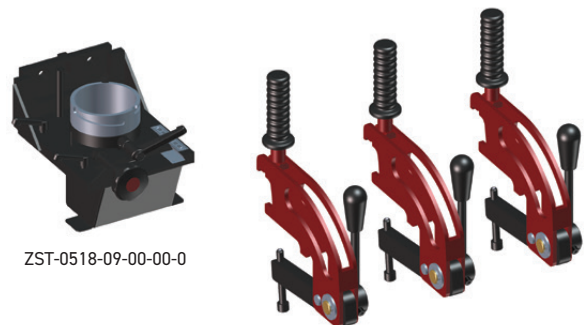

All information is subject to change without notice. 24.05



PROMOTECH Sp. z o.o.  
ul. Elewatorska 23/1, 15-620 BIAŁYSTOK, POLAND  
tel. (+48 85) 678 34 05, fax (+48 85) 662 78 77  
marketing@promotech.eu www.promotech.eu

Your local dealer:

