

■ ABM-29

AUTO-FEED DOUBLE-SIDE HEAVY DUTY PORTABLE BEVELLER



In order to meet ever growing quality and efficiency requirements for heavy bevelling in metalworking industries, Promotech is introducing a new portable machine for double-sided heavy plate machining. As in the already known ABM-14 beveller the new ABM-29 machine is using a shearing method for bevelling.

ABM-29 is a self-propelled heavy-duty machine which can bevel up to 20 mm width just in one pass.

The ABM-29 performs double-sided bevels between 20 and 45 degrees on a variety of steels, including stainless steel and other special steel plates, without the need to turn the plate over.

This beveller is equipped with an ergonomically designed trolley for transport and storage. For machining of smaller parts or pipes with ID > 150 mm, stationary operation with ABM-29 is also possible.



■ Features & benefits:

- **Heavy-duty beveller** which auto travels along an edge of a plate with speeds of up to 1.7 m/min.
- **Up to 20 mm bevel width in one run** and maximum 29 mm bevel width after multi passes
- Continuous milling height/bevel width adjustment
- **Continuous bevel angle adjustment between 20 and 45 degrees**
- **Integrated trolley to facilitate top & bottom bevelling** with height adjustment between 685 and 1000 mm
- **Stationary operation** for machining small workpieces
- Pipe machining with minimum ID 150 mm (6")
- **Overload protection**
- Reverse travel mode to free jammed tool
- ABM-29 is a **low-noise machine**

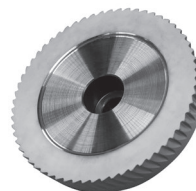

- **One shearing cutter** for machining of a variety of steel grades incl. stainless and other alloy steels

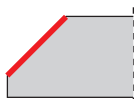

Top bevelling

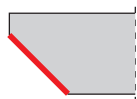

Bottom bevelling

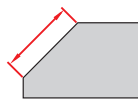

Bevel width up to 29 mm



Bevel angles
top 20° - 45°
bottom 20° - 45°



Max plate thickness
50 mm



Pipe OD beveling
Min. ID 150 mm (6")

Single run beveling up to 20 mm width

Depending on sort of material up to 20 mm bevel width is possible with ABM-29 in a single run.

CARBON STEELS	SINGLE RUN BEVELLING TABLE						
	β	20°	25°	30°	35°	37.5°	45°
Rm ≤ 392 Mpa (57,000 psi)	B	20	20	20	20	20	20
	h	19	18	17.5	16.5	16	14
Rm = 392-490 Mpa (57,000-71,000 psi)	B	16	16	16	16	16	16
	h	15	14.5	14	13	12.5	11.5
Rm = 490-588 Mpa (71,000-85,000 psi)	B	13	13	13	13	13	13
	h	12.5	12	11	10.5	10	9

STAINLESS - ALLOY STEELS	SINGLE RUN BEVELLING TABLE						
	β	20°	25°	30°	35°	37.5°	45°
Rm ≤ 490 Mpa (71,000 psi)	B	9.5	9.5	9.5	9.5	9.5	9.5
	h	9	8.5	8	8	7.5	6.5
Rm = 490-588 Mpa (71,000-85,000 psi)	B	8	8	8	8	8	8
	h	7.5	7.5	7	6.5	6.5	5.5
Rm = 588-686 Mpa (85,000-100,000 psi)	B	7	7	7	7	7	7
	h	6.5	6.5	6	6	5.5	5

Bevel width up to 29 mm at 45 degrees

- Various bevel widths (B) are possible by means of ABM-29
- The final results depend on combination of bevel angle (β) and bevel height (h)

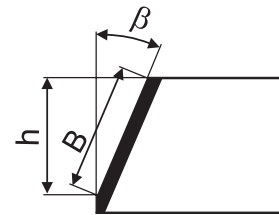
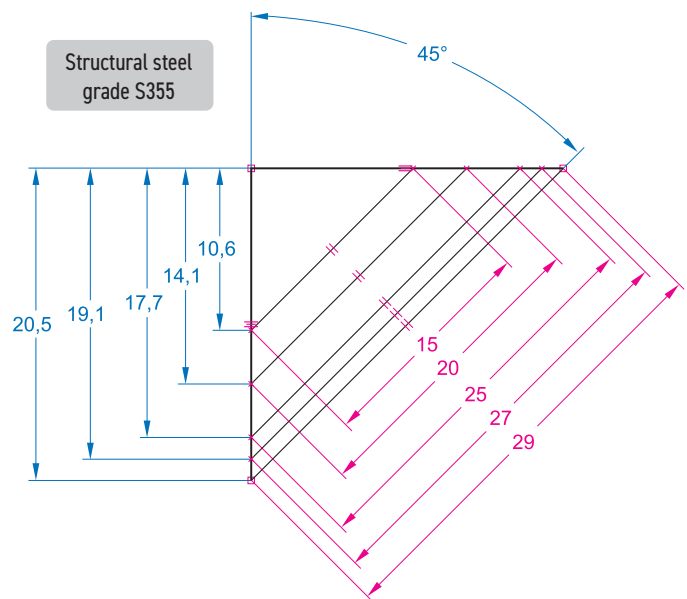
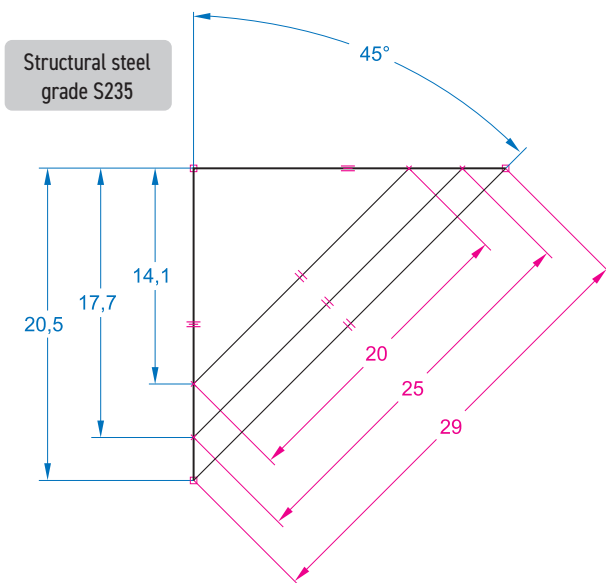

Fig. 1

Machining step-by-step

A maximum bevel width of 29 mm can be achieved in multiple passes by progressively increasing the head penetration into the material. The number of passes depends on the grade of material.



Precise adjustment of the process parameters: bevel angle, bevel depth and material thickness



Machining thick plate

Automatic feed allows ABM-29 to travel along the top and bottom edges of the plate.

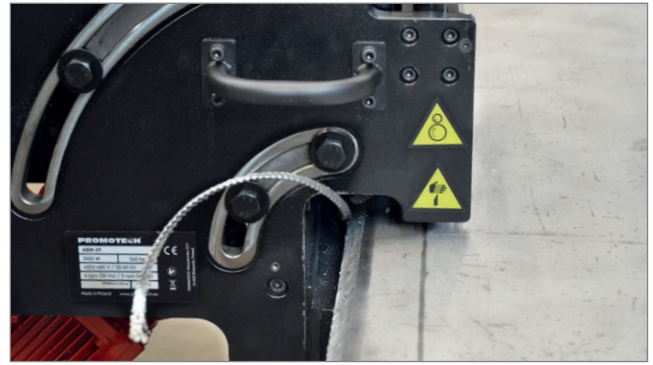
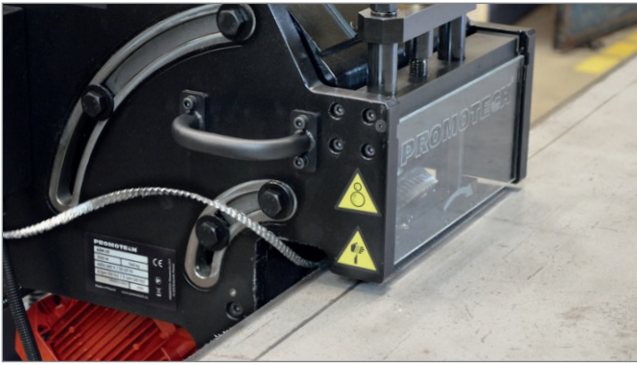

Machining longitudinal workpieces

Stationary operation is possible for machining smaller workpieces.

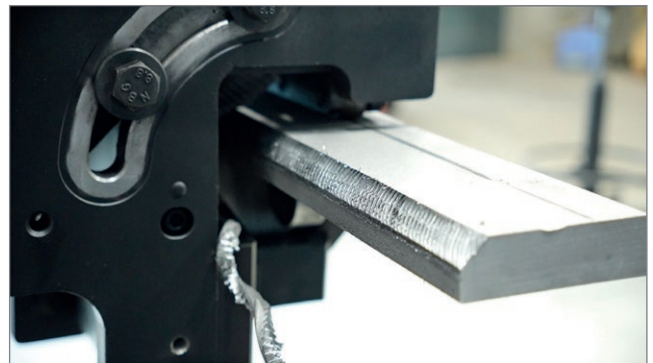

Machining pipes

ABM-29 can also bevel pipes with ID bigger than 150 mm (6").

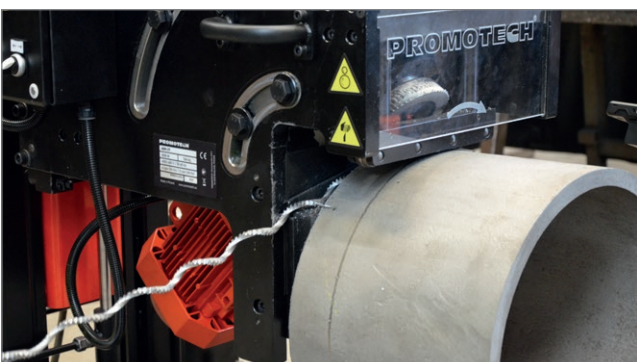

Operation in the inverted position

The trolley allows the machine to rotate 180 degrees up and down to create top and bottom bevels without having to flip the plate. It is easy one-man operation. A mechanical lock secures the machine in the upper or inverted position.

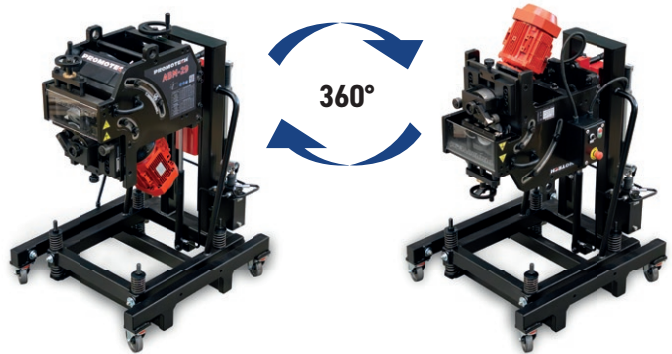
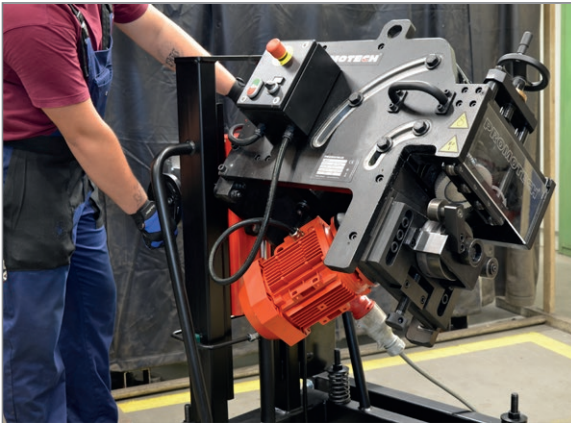

ABM-29 TECHNICAL SPECIFICATION	
Voltage	3x400 V / 3x480 V + PE, 50-60 Hz / 3x240 50-60 Hz
Power	3000 W
Spindle speed	4 rpm (for 50 Hz); 5 rpm (for 60 Hz)
Bevel angle (β , Fig. 1)	20°-45°
Maximum bevel width (B, Fig. 1)	29 mm
Maximum bevel in one single run	20 mm
Maximum height of cut (h, Fig. 1)	14.5 mm
Minimum plate thickness	10 mm
Maximum plate thickness	40 mm (50 mm*)
Minimum plate width	80 mm
Bevel length per minute	1.7 m/min for 50 Hz; 1.9 m/min for 60 Hz
Minimum pipe ID	150 mm
Weight	540 kg
Product Code	UKS-0808-10-40-00-00-0

* for 50 mm thick plate, the minimum bevel width is 15 mm.

Shipping set:

- Beveling machine with built-in trolley
- Transport box
- Flat wrench 32-36 mm, 30-32 mm, 24-27 mm
- Shearing cutter
- Hex wrench 14 mm, 8 mm, 6 mm, 4 mm
- Operator's Manual



Single shearing cutter for various materials.

Possible types of bevels

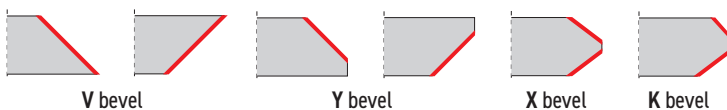

More information available at www.promotech.eu

Hydraulic height adjustment

Built-in ergonomic trolley features a hydraulic height adjustment from 685 to 1000 mm.



Dedicated transportation trolley locks, stiffen the machine for stationary work.

